

UN8-6 (6V8.0Ah)

GENERAL FEATURES



- Absorbent Glass Mat (AGM) technology for efficient gas recombination of up to 99% and freedom from electrolyte for air transport-complies with LATA/ICAO Special provision A67.
- Not restricted for air transport-complies with LATA/ICAO Special Provision A67.
- UL-recognized component.
- Can be mounted in any orientation.
- Computer designed lead, calcium tin alloy grid for high power density.
- Long service life, float or cyclic applications,
- Maintenance-free operation.
- Low self discharge.
- Case and cover available in both standard and flame retardant ABS.

SPECIFICATION

Nominal voltage	6V	Dimensions	Total Height	3.94inches(100mm)
Rated capacity (20 hour rate)	8Ah		Height	3.70inches(94mm)
Number of cell	3		Length	5.94inches(151mm)
Approx. Weight (Kg / lbs)	1.23/2.71		Width	1.34inches(34mm)

Battery Dimensions

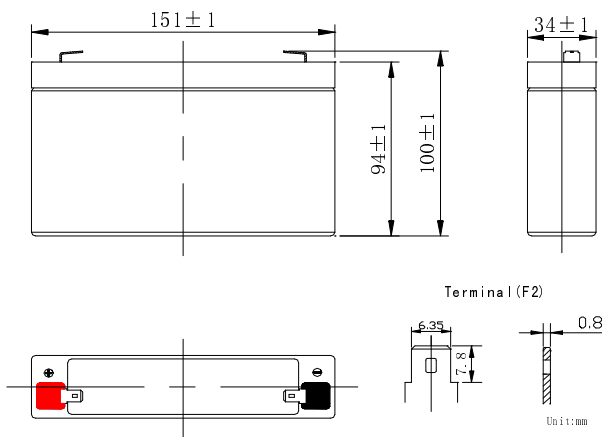

Characteristics

Capacity 77° F (25°C)	20 hour rate (0.4A、10.5V)	8Ah
	10 hour rate (0.76A、10.5V)	7.6Ah
	5 hour rate (1.38A、10.5V)	6.9Ah
	1 hour rate (4.9 A、9.6V)	4.9Ah
	1C (8A、9.6V)	32min
	3C (24A、9.6V)	7min
Internal Resistance	Full charged Battery 77° F (25°C) : 14m Ω	
Capacity affected by Temperature (20 hour rate)	104° F (40°C)	102%
	77° F (25°C)	100%
	32° F (10°C)	85%
	5° F (-15°C)	65%
Self-Discharge 68° F (20°C)	Capacity after 3 month storage	90%
	Capacity after 6 month storage	80%
	Capacity after 12month storage	60%
Max. discharge current 77° F (25°C) : 120A (5S)		
Charge (Constant Voltage)	Float: 6.8~6.9 V/77° F (25°C)	
	Cycle: 7.25~7.45V/77° F (25°C) Max. Current: 2A	

Constant power discharge ratings-watts per cell at 25°C (77° F)

End Point Volts/Cell	5min	10min	15min	30min	45min	1h	2h	3h	5h
1.60V	63.0	40.3	33.0	18.9	14.2	11.1	7.51	4.67	3.10
1.65V	59.1	37.9	31.2	17.9	13.6	10.6	7.29	4.56	3.06
1.70V	55.2	35.6	29.4	17.0	12.9	10.1	7.04	4.43	3.00
1.75V	51.4	33.2	27.6	16.0	12.2	9.61	6.77	4.22	2.92
1.80V	47.6	30.9	25.7	15.0	11.5	9.09	6.47	4.02	2.81

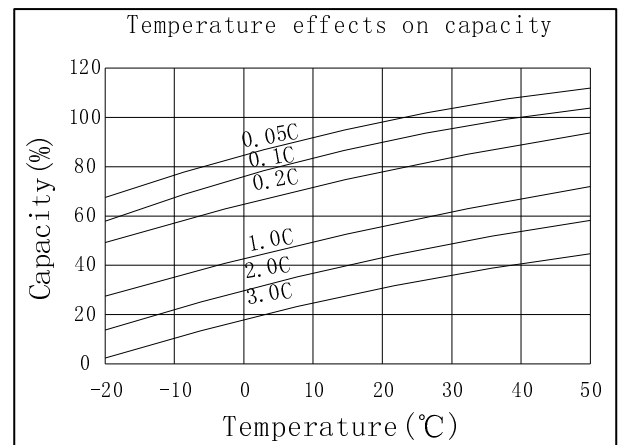
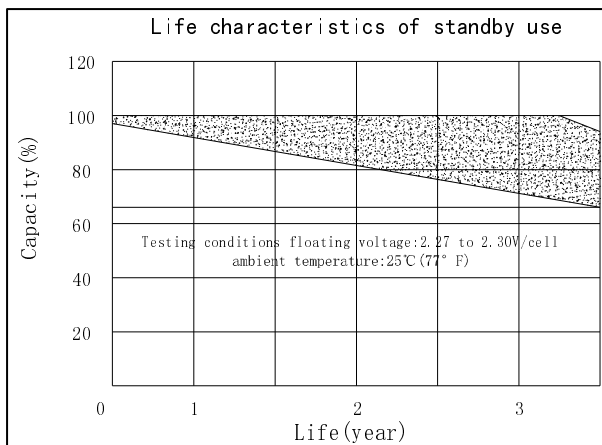
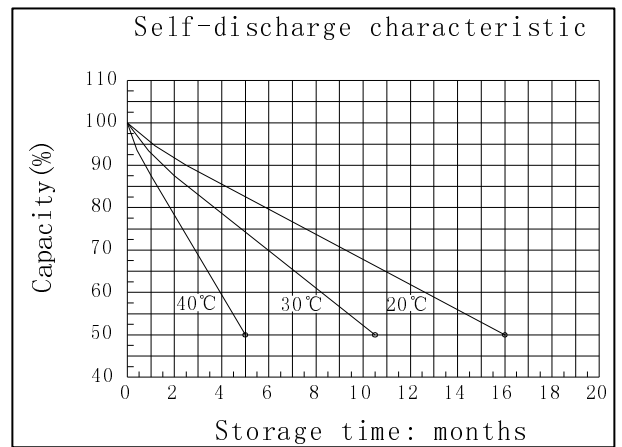
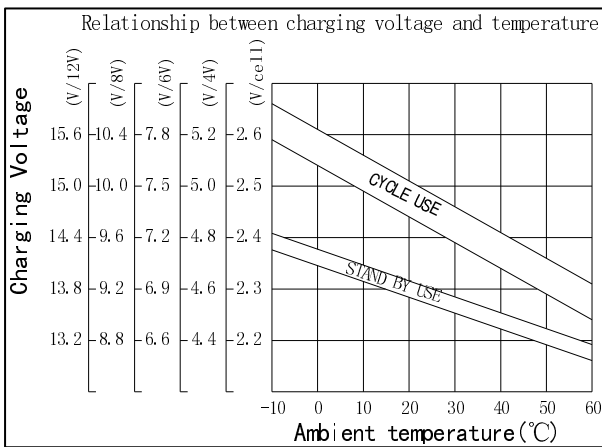
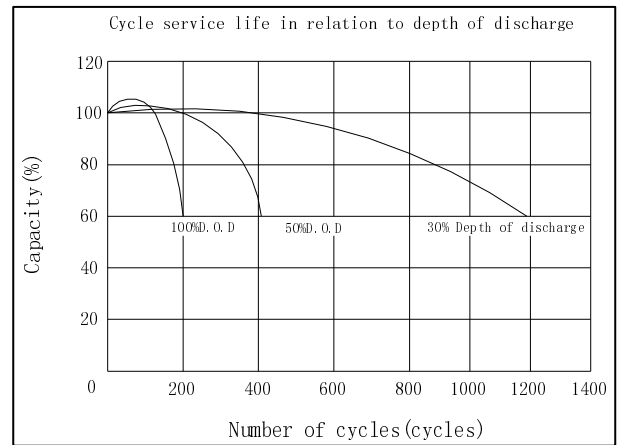
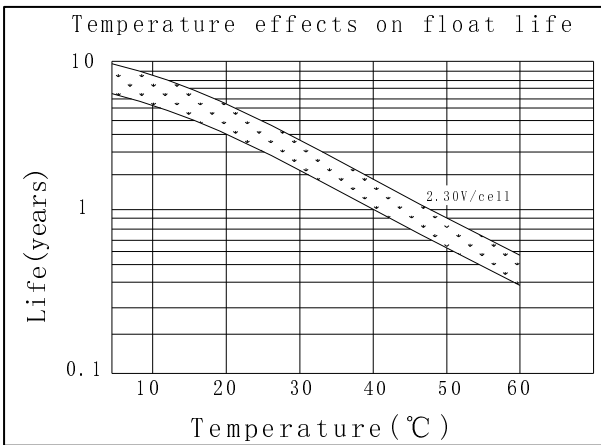
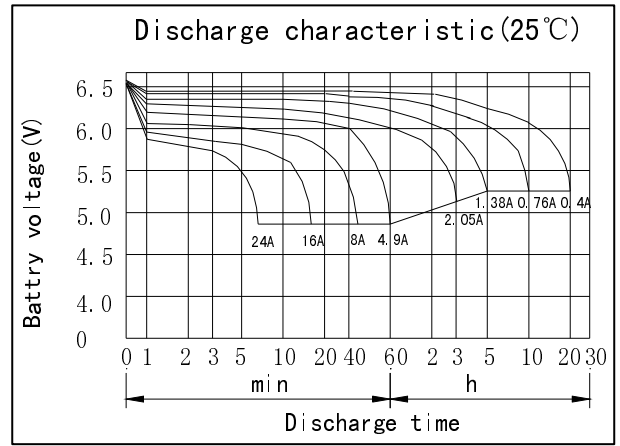
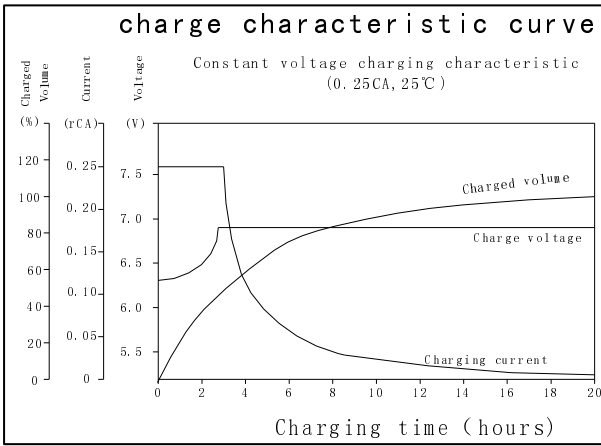

OREMA POWER CO., LTD

Add: Datang Industry Park Xinfeng Ganzhou City, Jiangxi Province, China

TEL: +86-0797-2299669 +86-0797- 2299553

FAX: +86-0797-2299553



www.oremabattery.com